

## Fast Switching EmCon Diode

### Feature

- 1200 V EmCon technology
- Fast recovery
- Soft switching
- Low reverse recovery charge
- Low forward voltage
- Easy paralleling
- Pb-free lead plating; RoHS compliant
- Qualified according to JEDEC<sup>0)</sup> for target applications

### Product Summary

$V_{RRM}$	1200	V
$I_F$	18	A
$V_F$	1.65	V
$T_{jmax}$	150	°C

PG-TO220-2-2.

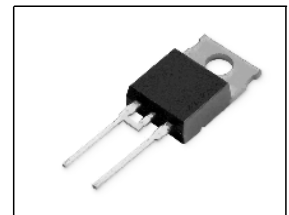

Type	Package	Ordering Code	Marking	Pin 1	PIN 2	PIN 3
IDP18E120	PG-TO220-2-2.	-	D18E120	C	A	-

### Maximum Ratings, at $T_j = 25\text{ °C}$ , unless otherwise specified

Parameter	Symbol	Value	Unit
Repetitive peak reverse voltage	$V_{RRM}$	1200	V
Continuous forward current	$I_F$	18	A
$T_C=25\text{ °C}$		31	
$T_C=90\text{ °C}$		19.8	
Surge non repetitive forward current	$I_{FSM}$	78	
$T_C=25\text{ °C}$ , $t_p=10\text{ ms}$ , sine halfwave			
Maximum repetitive forward current	$I_{FRM}$	47	
$T_C=25\text{ °C}$ , $t_p$ limited by $T_{jmax}$ , $D=0.5$			
Power dissipation	$P_{tot}$	113	W
$T_C=25\text{ °C}$		113	
$T_C=90\text{ °C}$		54	
Operating and storage temperature	$T_j, T_{stg}$	-55...+150	°C
Soldering temperature	$T_S$	260	°C
wavesoldering, 1.6mm (0.063 in.) from case for 10s			

**Thermal Characteristics**

Parameter	Symbol	Values			Unit
		min.	typ.	max.	
<b>Characteristics</b>					
Thermal resistance, junction - case	$R_{thJC}$	-	-	1.1	K/W
Thermal resistance, junction - ambient, leaded	$R_{thJA}$	-	-	62	
SMD version, device on PCB: @ min. footprint @ 6 cm <sup>2</sup> cooling area <sup>1)</sup>	$R_{thJA}$	-	-	62	
		-	35	-	

**Electrical Characteristics, at  $T_j = 25\text{ }^\circ\text{C}$ , unless otherwise specified**

Parameter	Symbol	Values			Unit
		min.	typ.	max.	
<b>Static Characteristics</b>					
Reverse leakage current $V_R=1200\text{V}$ , $T_j=25^\circ\text{C}$ $V_R=1200\text{V}$ , $T_j=150^\circ\text{C}$	$I_R$	-	-	100 1400	$\mu\text{A}$
Forward voltage drop $I_F=18\text{A}$ , $T_j=25^\circ\text{C}$ $I_F=18\text{A}$ , $T_j=150^\circ\text{C}$	$V_F$	-	1.65 1.7	2.15 -	V

<sup>0</sup>J-STD20 and JESD22

<sup>1</sup>Device on 40mm\*40mm\*1.5mm epoxy PCB FR4 with 6cm<sup>2</sup> (one layer, 70  $\mu\text{m}$  thick) copper area for drain connection. PCB is vertical without blown air.

**Electrical Characteristics, at  $T_j = 25\text{ }^\circ\text{C}$ , unless otherwise specified**

Parameter	Symbol	Values			Unit
		min.	typ.	max.	
<b>Dynamic Characteristics</b>					
Reverse recovery time $V_R=800\text{V}$ , $I_F=18\text{A}$ , $di_F/dt=800\text{A}/\mu\text{s}$ , $T_j=25^\circ\text{C}$ $V_R=800\text{V}$ , $I_F=18\text{A}$ , $di_F/dt=800\text{A}/\mu\text{s}$ , $T_j=125^\circ\text{C}$ $V_R=800\text{V}$ , $I_F=18\text{A}$ , $di_F/dt=800\text{A}/\mu\text{s}$ , $T_j=150^\circ\text{C}$	$t_{rr}$	-	195 280 300	-	ns
Peak reverse current $V_R=800\text{V}$ , $I_F = 18\text{A}$ , $di_F/dt=800\text{A}/\mu\text{s}$ , $T_j=25^\circ\text{C}$ $V_R=800\text{V}$ , $I_F = 18\text{A}$ , $di_F/dt=800\text{A}/\mu\text{s}$ , $T_j=125^\circ\text{C}$ $V_R=800\text{V}$ , $I_F = 18\text{A}$ , $di_F/dt=800\text{A}/\mu\text{s}$ , $T_j=150^\circ\text{C}$	$I_{rrm}$	-	20.2 24.4 25.3	-	A
Reverse recovery charge $V_R=800\text{V}$ , $I_F=18\text{A}$ , $di_F/dt=800\text{A}/\mu\text{s}$ , $T_j=25^\circ\text{C}$ $V_R=800\text{V}$ , $I_F = 18\text{A}$ , $di_F/dt=800\text{A}/\mu\text{s}$ , $T_j=125^\circ\text{C}$ $V_R=800\text{V}$ , $I_F = 18\text{A}$ , $di_F/dt=800\text{A}/\mu\text{s}$ , $T_j=150^\circ\text{C}$	$Q_{rr}$	-	1880 3200 3540	-	nC
Reverse recovery softness factor $V_R=800\text{V}$ , $I_F=18\text{A}$ , $di_F/dt=800\text{A}/\mu\text{s}$ , $T_j=25^\circ\text{C}$ $V_R=800\text{V}$ , $I_F=18\text{A}$ , $di_F/dt=800\text{A}/\mu\text{s}$ , $T_j=125^\circ\text{C}$ $V_R=800\text{V}$ , $I_F=18\text{A}$ , $di_F/dt=800\text{A}/\mu\text{s}$ , $T_j=150^\circ\text{C}$	S	-	5.5 6.6 6.7	-	

**1 Power dissipation**

$$P_{tot} = f(T_C)$$

parameter:  $T_j \leq 150^\circ\text{C}$

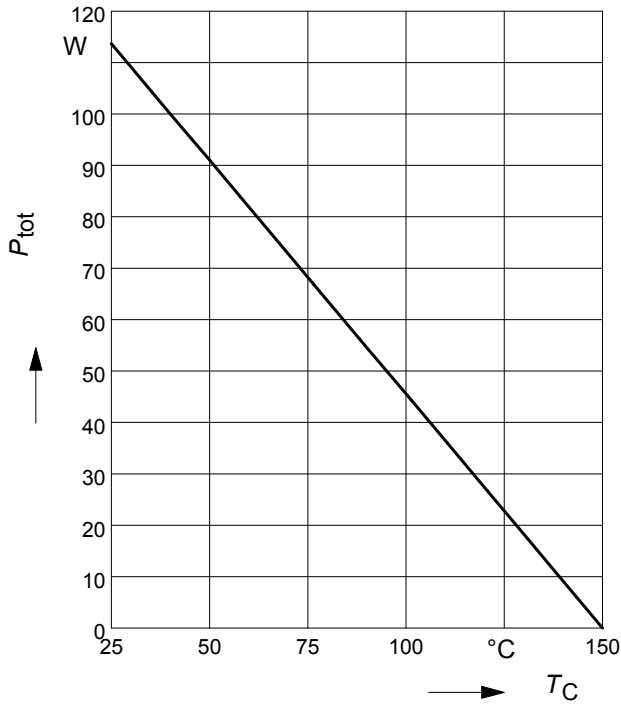

**2 Diode forward current**

$$I_F = f(T_C)$$

parameter:  $T_j \leq 150^\circ\text{C}$

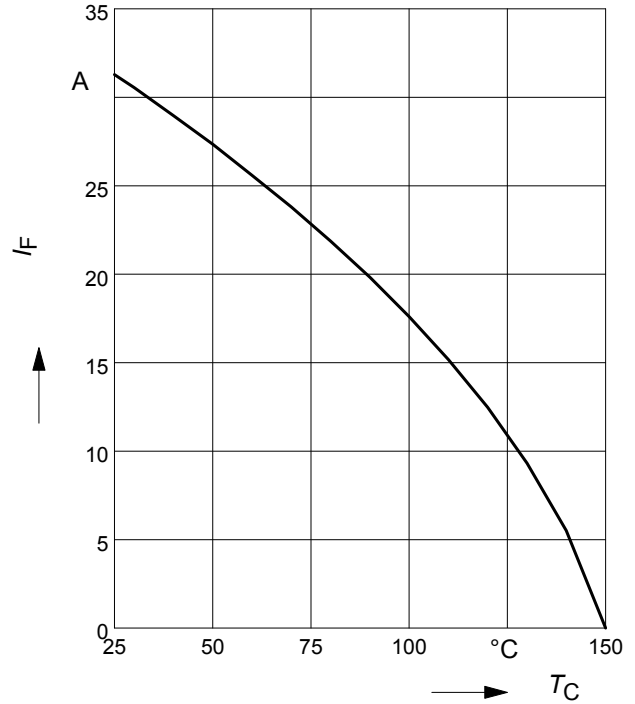

**3 Typ. diode forward current**

$$I_F = f(V_F)$$

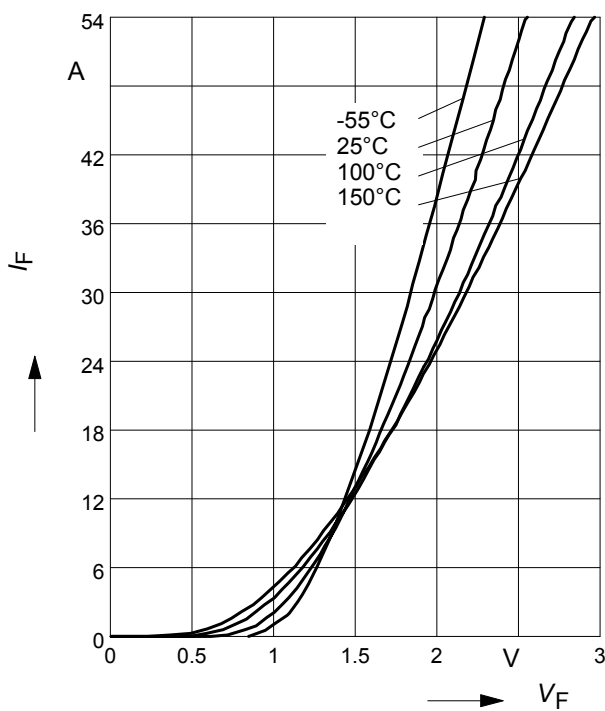

**4 Typ. diode forward voltage**

$$V_F = f(T_j)$$

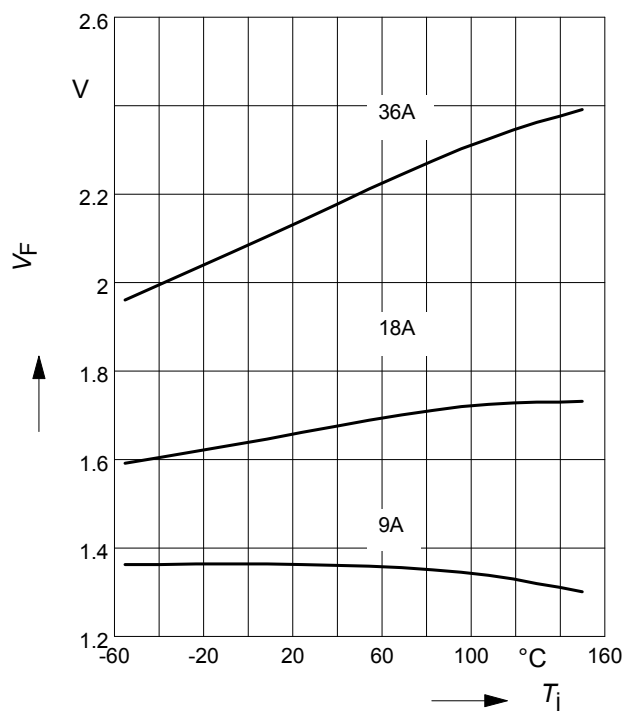

**5 Typ. reverse recovery time**

$$t_{rr} = f(di_F/dt)$$

parameter:  $V_R = 800V, T_j = 125^\circ C$

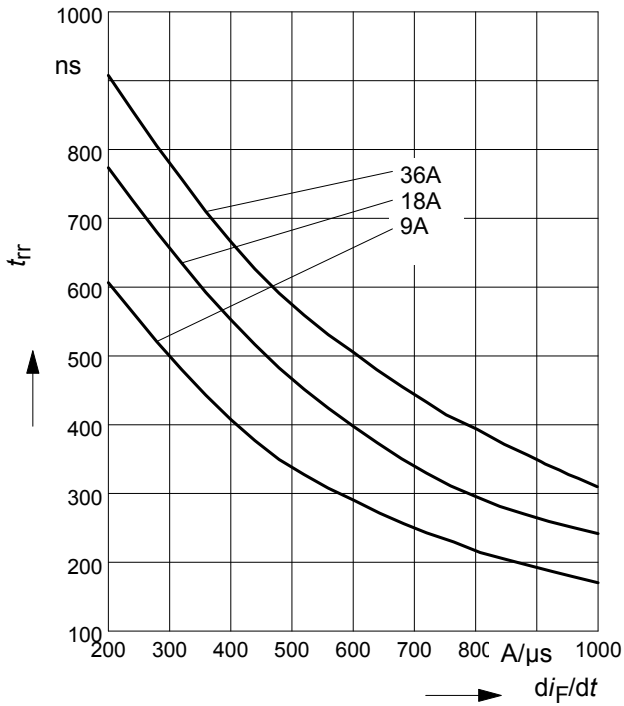

**6 Typ. reverse recovery charge**

$$Q_{rr} = f(di_F/dt)$$

parameter:  $V_R = 800V, T_j = 125^\circ C$

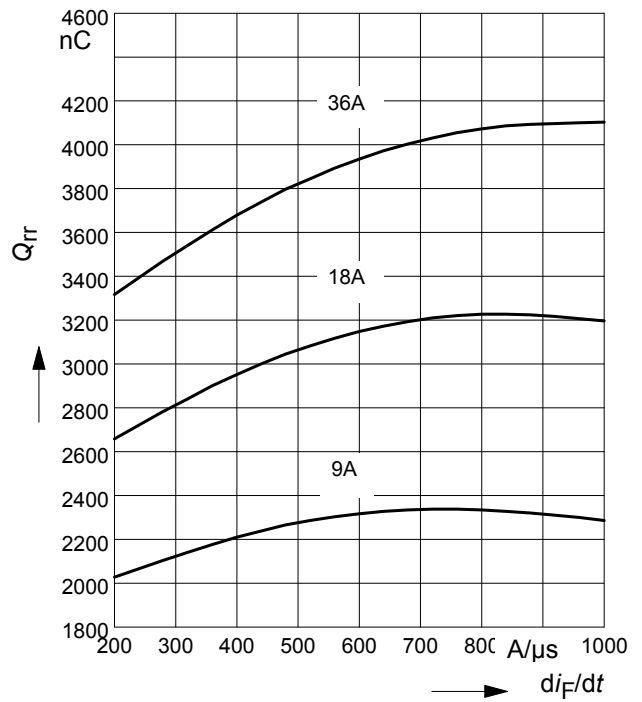

**7 Typ. reverse recovery current**

$$I_{rr} = f(di_F/dt)$$

parameter:  $V_R = 800V, T_j = 125^\circ C$

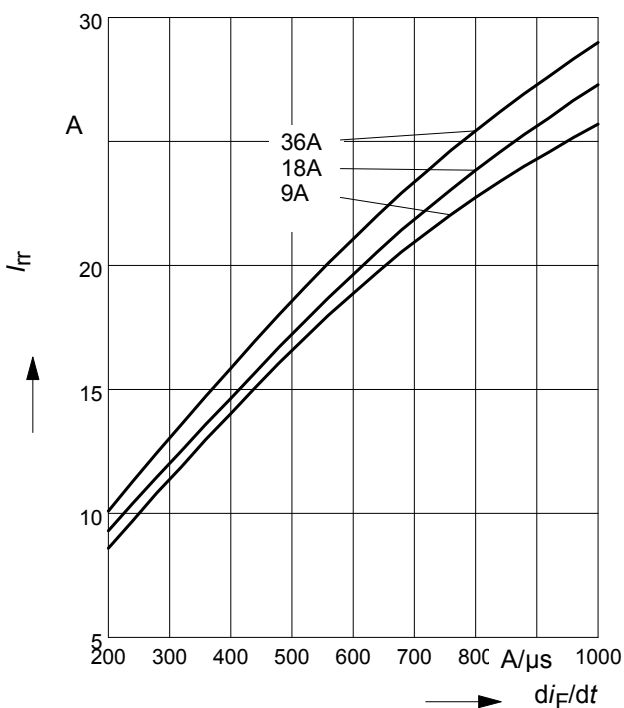

**8 Typ. reverse recovery softness factor**

$$S = f(di_F/dt)$$

parameter:  $V_R = 800V, T_j = 125^\circ C$

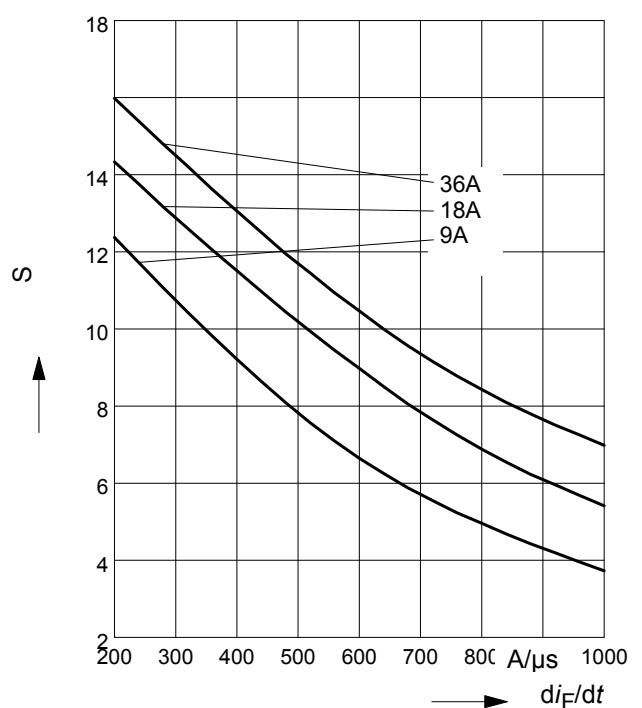

**9 Max. transient thermal impedance**

$$Z_{thJC} = f(t_p)$$

parameter :  $D = t_p/T$

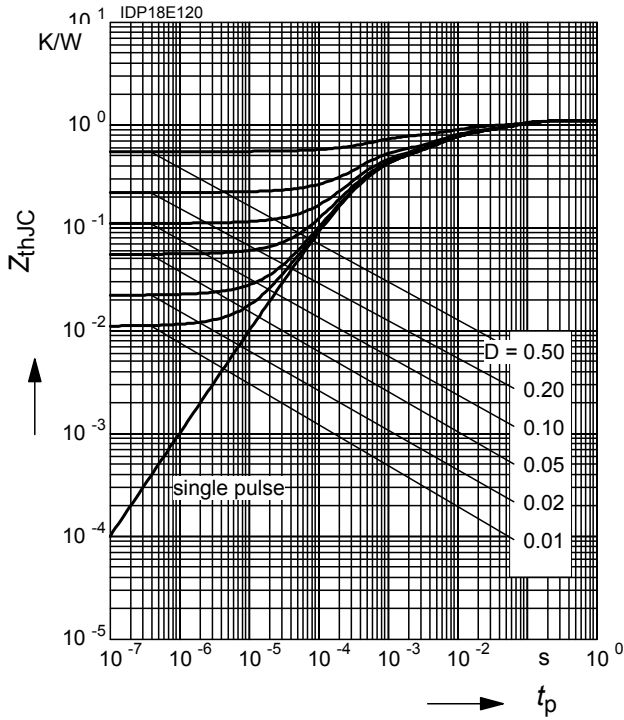

TO-220-2-2

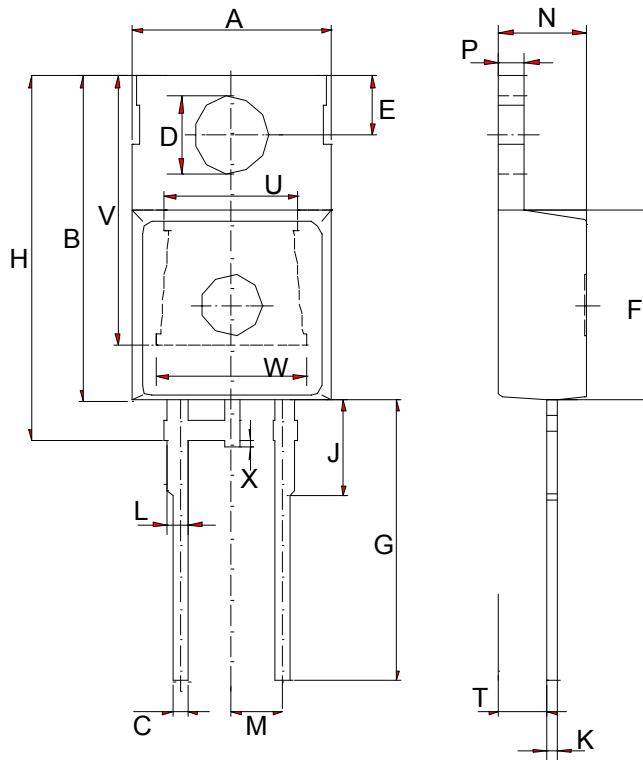

symbol	dimensions			
	[mm]		[inch]	
	min	max	min	max
A	9.70	10.10	0.3819	0.3976
B	15.30	15.90	0.6024	0.6260
C	0.65	0.85	0.0256	0.0335
D	3.55	3.85	0.1398	0.1516
E	2.60	3.00	0.1024	0.1181
F	9.00	9.40	0.3543	0.3701
G	13.00	14.00	0.5118	0.5512
H	17.20	17.80	0.6772	0.7008
J	4.40	4.80	0.1732	0.1890
K	0.40	0.60	0.0157	0.0236
L	1.05 typ.		0.41 typ.	
M	2.54 typ.		0.1 typ.	
N	4.4 typ.		0.173 typ.	
P	1.10	1.40	0.0433	0.0551
T	2.4 typ.		0.095 typ.	
U	6.6 typ.		0.26 typ.	
V	13.0 typ.		0.51 typ.	
W	7.5 typ.		0.295 typ.	
X	0.00	0.40	0.0000	0.0157

**Published by**  
**Infineon Technologies AG,**  
**Bereichs Kommunikation**  
**St.-Martin-Strasse 53,**  
**D-81541 München**  
**© Infineon Technologies AG 1999**  
**All Rights Reserved.**

**Attention please!**

The information herein is given to describe certain components and shall not be considered as warranted characteristics.

Terms of delivery and rights to technical change reserved.

We hereby disclaim any and all warranties, including but not limited to warranties of non-infringement, regarding circuits, descriptions and charts stated herein.

Infineon Technologies is an approved CECC manufacturer.

**Information**

For further information on technology, delivery terms and conditions and prices please contact your nearest Infineon Technologies Office in Germany or our Infineon Technologies Representatives worldwide (see address list).

**Warnings**

Due to technical requirements components may contain dangerous substances.

For information on the types in question please contact your nearest Infineon Technologies Office.

Infineon Technologies Components may only be used in life-support devices or systems with the express written approval of Infineon Technologies, if a failure of such components can reasonably be expected to cause the failure of that life-support device or system, or to affect the safety or effectiveness of that device or system. Life support devices or systems are intended to be implanted in the human body, or to support and/or maintain and sustain and/or protect human life. If they fail, it is reasonable to assume that the health of the user or other persons may be endangered.